

MAXIMUM PCB SIZE

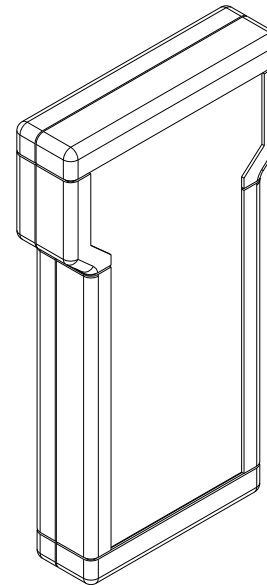
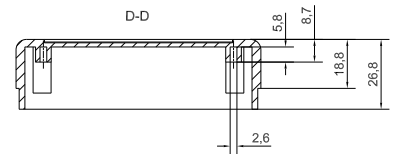
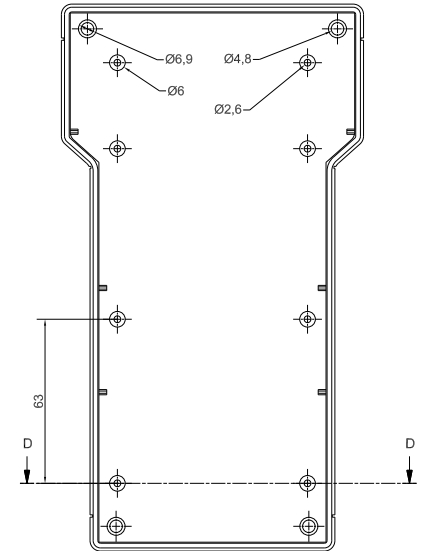
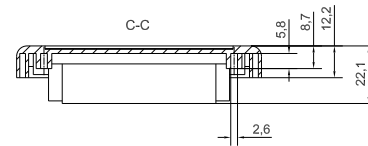
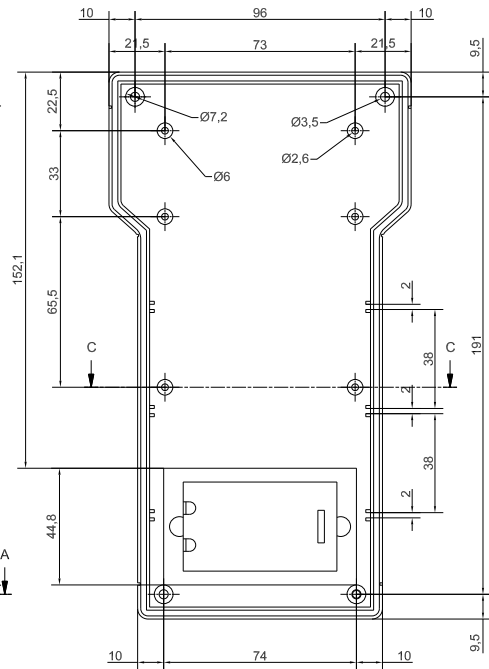
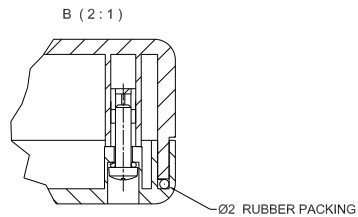
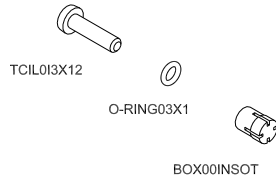
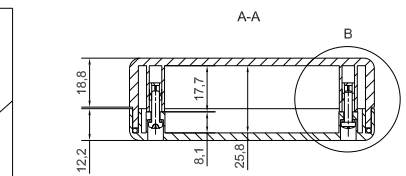
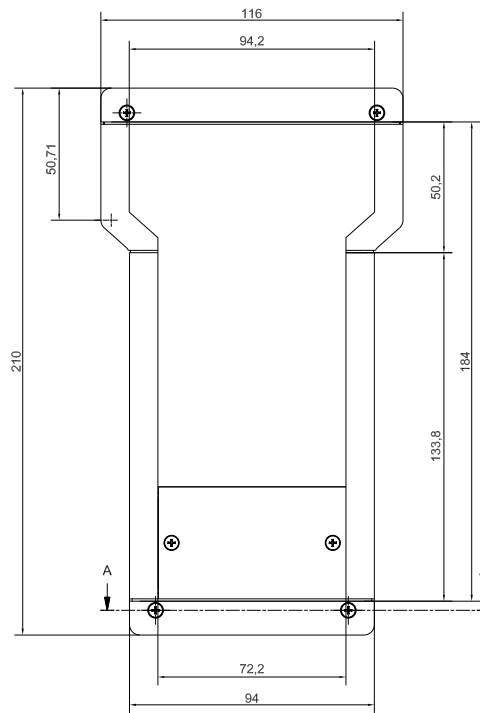
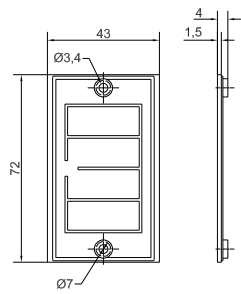
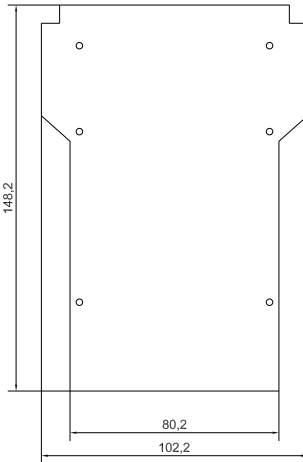

	Description Assembly TBT-2BK	Part Number TBT-2BK
	Subject to technical modification without prior notice. Tipographical and other errors do not justify any claim for damages. All dimensions should be verified using an actual moulded part.	Rev. Code Date 16/06/2005
This document contains proprietary information of TEKO S.p.A. and is licensed subject to the conditions that the information be released in confidence and not be reproduced or copied and not be used or incorporated in any product.	Scale 1:1	Drawing Sheet A1